

THERMORY®

REAL WOOD DECKING WITH BEAUTY AND LONGEVITY IN EVERY FIBER

Decking boards and
modular systems



Thermory decking represents the union of expert science and modern design.

Each board is carefully modified with heat and steam, then meticulously milled to create stunningly consistent, straight, reliable boards. Unoiled, Thermory decking will gradually mature to a beautiful, rustic silver patina.

Thermory decking combines the high function your project requires with the natural artistic beauty you desire.





Benchmark by Thermory thermo-ash decking (D4. Installation: screws), Maidla Nature Villa in Estonia.
Designed by Mari Hunt, b210 Architects. Photo by Elvo Jakobson

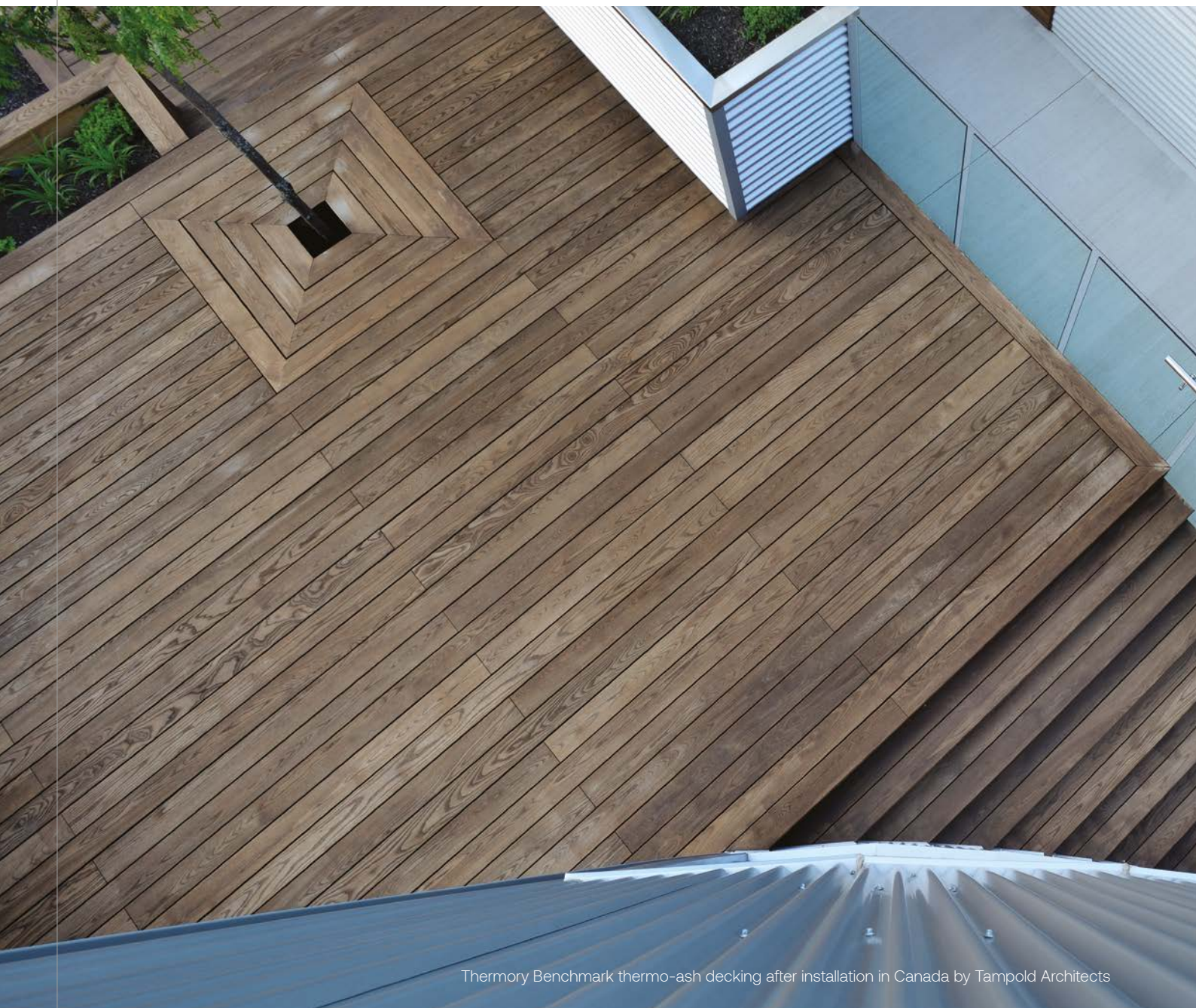

Thermory Benchmark thermo-ash decking after installation in Canada by Tampold Architects

| | | | |
|---------------------------------------|----|-------------------------------------|----|
| 1. We are Thermory® | 5 | 5. Thermory Modular Decking Systems | 26 |
| 2. Thermory® Wood species for decking | 8 | 5.1 Quickdeck by Thermory | 26 |
| 3. Thermory Benchmark Series | 10 | 5.2 Flow by Thermory | 27 |
| 3.1 Hidden installation | 11 | 5.3 Herringbone by Thermory | 28 |
| 3.1.1 Installation: PaCS® | 11 | | |
| 3.1.2 Installation: T-4, T-6 clip | 15 | 6. Additional information | 29 |
| 3.1.3 Installation: PC clip | 17 | 6.1 Board lengths | 29 |
| 3.1.4 Installation: SUPRO H clip | 17 | 6.2 Surface textures | 29 |
| 3.1.5 Installation: TENI® clip | 18 | 6.3 Storage | 29 |
| 3.2 Installation with screws | 19 | 6.4 Installation | 30 |
| 4. Thermory Rebel Series | 25 | 6.5 Maintenance | 31 |
| 4.1 Kodiak by Thermory | 25 | | |



1. We are Thermory®

Using only heat and steam, we create extremely durable and climate-resistant decking, cladding, flooring, wall paneling and sauna products that are unrivaled in both performance and sustainability compared with the usual alternatives such as plastic composites, chemically treated woods and tropical hardwoods.

Thermory wood can be found in more than 50 countries around the world; in homes and public spaces, in a variety of buildings and environments, in high humidity and extreme heat, in cold and in warmth. Our broad selection of products meets the needs of hundreds of diverse tastes and styles.

Our purchasing process is environmentally responsible, and we exercise high standards for quality and sustainability.

Our timber is carefully inspected and harvested from sustainably managed forests, never from endangered, tropical or rainforest woodland. If desired, we can offer PEFC, FSC or Nordic Swan Ecolabel-certified wood.



100% REAL WOOD PRODUCTS



QUALITY MATERIALS

An unbeatable range of wood species, profiles and finishes



INDUSTRY EXPERTS

Delivering superior quality and unrivaled beauty for over 20 years



SUSTAINABLE

Wood from sustainably managed forests with chemical-free modification





Benchmark by Thermory thermo-ash decking (D4. Installation: screws). Maidla Nature Villa in Estonia.
Designed by Mari Hunt, b210 Architects. Photo by Elvo Jakobson

Thermory's expertise is in the process and technology of thermally modified wood

Thermal modification is a way of naturally enhancing wood. The chemical-free heat treatment makes the wood extremely durable and stable for both indoor and outdoor use, giving it a beautifully deep shade and bringing out its natural beauty.

Unlike chemical impregnation, Thermory's thermal modification enhances the wood throughout, not just the outer surface. The result is quality boards that are stable and durable in every sense.



→ **THE HEAT**

ENHANCES THE WOOD'S STRUCTURE THROUGHOUT

→ **THE STEAM**

GIVES US FULL CONTROL OVER THE PROCESS

| | | | | | |
|--|------------------------------------------------------------------------------------------|--|-------------------------------------------------------------------------------------------------------|--|----------------------------------------------------------------------------------|
| | <p>THERMALLY MODIFIED WOOD Naturally enhanced using only heat & steam</p> | | <p>DIMENSIONAL STABILITY Enhanced dimensional stability in changing weather conditions</p> | | <p>CHEMICAL-FREE Thermal modification process is entirely natural</p> |
| | <p>DURABILITY Improved durability and rot resistance</p> | | <p>WALK BAREFOOT The decking doesn't overheat in the sun</p> | | <p>NON-HAZARDOUS WASTE Safe waste handling</p> |

2. Thermory® Wood species for decking

Thermory offers thermally modified real wood decking products in a wide range of profiles and dimensions, produced mostly on order. This brochure aims to work as a guide and tool for searching the various wood types and profile options already

available, either standard or custom made.

Contact our sales team info@thermory.com for guidance on minimum order quantities, availability, lead times and production location.

● All Thermory decking boards undergo intense thermal modification and are durable, stable and rot-resistance without additional surface treatment.

● Using the correct installation and supplemental maintenance techniques will result in the most beautiful and long-lasting decking.

This process can take a few months to several years depending on how much UV light they are exposed to.

● Natural look from thermal modification is warm brown.

● As with any other wood, the surface of thermally modified wood will acquire a natural silver gray colour over time.

● To preserve the tone of thermally modified wood, we recommend oiling the boards once a year using a UV-resistant pigmented oil.

THERMORY THERMO-ASH

HIGH-PERFORMANCE HARDWOOD THAT EXCEEDS EXPECTATIONS

Thermory's thermally modified ash products are a hardwood solution for exceptional rot-resistance and longevity combined with a clear face and rich brown color. This can offer sustainability benefits, for example by making thermo-ash a great alternative to tropical hardwood. Thermory thermo-ash has similar durability characteristics to tropical wood (class 1, 25+ years) with superior dimensional stability.

After installation



MODIFICATION LEVEL: INTENSE



25+
THERMALLY MODIFIED WOOD
YEARS AGAINST WOOD DECAY

● CLASS 1

According to CEN/TS 15083-1:2005

Uniled wood exposed to UV light

THERMORY THERMO-PINE

THE NEW DURABILITY STANDARD FOR SOFTWOOD

The natural look of thermally modified pine is golden-brown, with distinctive knots and more resin than other woods. Thermal modification adds decades of rot resistance to this softwood without using any chemicals.

After installation



MODIFICATION LEVEL: INTENSE



15+
THERMALLY MODIFIED WOOD
YEARS AGAINST WOOD DECAY

● CLASS 2

According to CEN/TS 15083-1:2005

Uniled wood exposed to UV light

THERMORY THERMO-SPRUCE

DURABLE SOFTWOOD WITH RUSTIC CHARM.

Spruce, sourced in Scandinavia and thermally modified by Thermory, offers a softwood solution with exceptional rot resistance and longevity combined with rustic knots and a naturally light golden-brown color. When installing reversible profiles, it's important to ensure that the heartwood (the side of the board closer to the center of the tree) is facing downwards.



MODIFICATION LEVEL: INTENSE

25+
YEARS
AGAINST
WOOD
DECAY

CLASS 1

According to CEN/TS
15083-1:2005

After installation

Unoiled wood exposed to UV light



Thermory Benchmark thermo-ash decking, aged and unoiled in France

3. Thermory Benchmark Series



BEAUTIFULLY SIMPLE, REMARKABLY DURABLE REAL WOOD PRODUCTS

Our Benchmark Series products define refined sophistication with simple solutions. Our innovative process results in products that are highly rot-resistant and environmentally friendly without sacrificing

strength or pliability; products with extraordinary longevity.

Sophisticated. Simple. Unrivaled.

Depending on the profile, Benchmark decking boards can be installed with screws, clips or PaCS – the world’s simplest hidden installation system.

Most profiles can be ordered with an end-matching solution, meaning that the joints don’t have to rest on joists, dramatically reducing wastage, labor costs and installation time.

On request available: brushing. Brushing increases the surface soundness of wood as the softer parts of wood are brushed out and scratches and bruising do not occur as easily.



DURABILITY

Highest available durability class for real wood



EASY INSTALLATION

Innovative and simple fixing methods

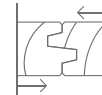

END-MATCHING AVAILABLE

Put joints wherever you want



STABILITY

Dimensionally stable in changing weather conditions



LOW MAINTENANCE

Oil it or not, the choice is yours

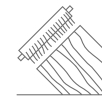

BRUSHING

Highlights the wood’s natural grain

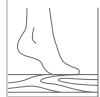

NO HOT FEET

Barefoot on the hottest day of the year? Absolutely.



Benchmark by Thermory thermo-pine decking in Norway
Distribution by Moelven. Photo by Einar Breen.

3.1 HIDDEN INSTALLATION



We offer various hidden installation accessories to create a beautiful screw-free decking surface. All of these fixings

also create sufficient air gaps between the boards to prevent moisture damage.

3.1.1 INSTALLATION: PACS®



DECKING INSTALLATION WITH JUST A PRESS, AND CLICK!

PaCS® product range combines high-quality Thermory thermowood with unique Grad® installation system. It is a hidden fastening solution designed for a quick and easy installation. Thermory PaCS consists of specially profiled Thermory boards with

grooves on the underside to perfectly fit the Grad clips or aluminum rails with pre-mounted Grad clips. As a result, there are no visible screw heads – the boards are simply pressed and clicked into place.



EASY INSTALLATION
Just press and click



HIDDEN FIXING
No visible screws

- PaCS products are also available as cladding.
- Standard selection available by pack. For the rest of products minimum order quantity applies.



The boards click into place when depressed and it's done.

○ Standard items

| PROFILE | WOOD | MODIFICATIONS | THICKNESS (MM) | WIDTH (MM) | PCS IN BUNDLE | INSTALLATION |
|---------|-------------|------------------|----------------|------------|---------------|-------------------------------------------------------------------------------------------------------------------------|
| D45J | Thermo-ash | Intense thermo ○ | 21 | 118 | 4 | PaCS® Strip: 7.5 pcs/1 sqm or PaCS Alu Rail 56 1.4 pcs/ 1 sqm or PaCS Alu Rail Start 1.4 pcs/1 sqm |
| D4J | Thermo-pine | Intense thermo ○ | 26 | 118 | 3 | |
| D30J | Thermo-ash | Intense thermo | 26 | 118 | 3 | |
| | Thermo-pine | Intense thermo | 26 | 118 | 3 | |



Benchmark by Thermory thermo-ash D45J, 21x118 mm



Benchmark by Thermory thermo-pine D45J, 26x118 mm



Benchmark by Thermory thermo-ash D4J, 26x118 mm

For PaCS® installation procedures and requirements please follow **Thermory Decking Installation Guide**. See also installation video on Thermory Youtube channel.

All pictures are for illustrative purposes only. Actual products may differ in appearance as wood is a natural material – each piece is unique, just like us.

PaCS® Strip is a fastening solution for PaCS decking. PaCS Strip is a six-clip strip that fixes three boards sideways onto one joist. These strips must be connected together and fixed to the joist, and the decking boards can then be easily snapped onto the clips. The strip will leave a 5-mm gap between the boards, and the clip thickness raises the board 5 mm above the joist to prevent wood-to-wood contact and ensure the required ventilation.

REQUIRED NUMBER OF PaCS STRIP:

7.5 strips per square meter of decking board including 4x30 mm stainless-steel screws + drill bit

PACKAGE: 300 strips, including screws



PaCS® Alu Rail 56 is a load-bearing aluminum joist with pre-mounted Grad clips. PaCS Alu Rail 56 is perfectly fitted with Top Lift pedestals. Ask your Thermory sales representative for the full range of installation accessories. Available special keys for board removal.

SIZE: 56 x 63,6 x 1984 mm

BOARD HEIGHT FROM SUBSTRUCTURE:
rail 56 mm + clips 6 = 62 mm

ESTIMATED NUMBER OF ALU RAIL 56 JOIST:
1.4 pcs per one square meter

PACKAGE:
1 rail (for 16 boards).



PaCS® Alu Rail Start is a non-load-bearing aluminum joist with pre-mounted Grad clips that can be laid on a flat surface or on wooden joists. It raises the boards 18 mm (rail 12 mm + Grad clips 6 mm), ensuring the required ventilation. Fix the rail with screws every 500 mm. Available special keys for board removal.

SIZE: 12 x 47 x 1984 mm

BOARD HEIGHT FROM SUBSTRUCTURE:
12 + 6 = 18 mm

ESTIMATED NUMBER OF PaCS ALU RAIL START: 1.4 pcs per one square meter of decking

PACKAGE: 1 rail (for 16 boards).



PACS® ALU RAIL 56 MATCHING PRODUCTS:

| PRODUCT CODE | PRODUCT NAME | WHOLESALE PACKAGING |
|----------------------|------------------------------------------------------------------------------------------------------------------------------------------------------------------------------------------------------------------------------------------------|---------------------|
| 1488 Top Link | Top Link Linking Piece for connecting the rails lengthwise and to maintain a uniform gap between the boards | 20 pcs/ bag |
| 1221 Rub strip | Rubber strip if you place PaCS Grad Alu Rail 56 directly on flat surface for decking. It helps to reduce noise resulting from friction between aluminium and the supporting surface. | 1 roll 16m |
| 1974 Span 400 | Spanner to maintain 400 mm span between rails | 1 pc |
| 1503 Span brack | Spanner fixing brackets set to fix angles for rails | 4 pcs/ bag |
| 1498 TC | Top Cube to fix skirting boards to the deck | 4 pcs/ bag |
| 1473 TC B1 | B1 Facia skirting fixing for one Top Cube, one 118mm board | 25 pcs/ box |
| 1474 TC B2 | B2 Facia skirting fixing for two Top Cubes, two 118mm boards | 25 pcs/ box |
| 1476 TC B3 | B3 Facia skirting fixing for three Top Cubes, three 118mm boards | 25 pcs/ box |
| 1241 TC screw | Screws for Top Cube 5x12mm can be used to fix aluminium skirting on Top Cube, or to fix angle brackets | 50 pcs/ bag |
| 1181 Top Lift | Top Lift Lift Pad adjustable pedestal for 35-65mm height (TopLift Lift Pad pedestal + TopLift Boosters + TopLift Stiffners = max 400mm height) | 1 pc |
| 1641 Ext 2 TL | Top Lift Booster pair allows to increase height (+45 mm). A maximum of 3 pairs of Boosters can be added up to the TopLift Lift Pad to reach 190 mm without Stiffeners. For height superior to 190 mm it is necessary to add Stiffeners. | 1 pair (2 units) |
| 1499 Stiffners TL | Top Lift Stiffners (67.5 mm) to ensure stability from Boosters for height above 190 mm | 1 pc |
| 1496 Slope corrector | Top Lift Slope corrector allows to compensate up to 4% of the slope | 1 pc |
| 968 Rem Keys | PaCS Alu Rail 118mm board removal keys | 2 pcs/ pack |



Benchmark by Thermory thermo-ash decking (PaCS D45J 21x118mm)
Private house in Estonia
Photo by Allan Leppikson



Benchmark by Thermory thermo-ash decking (PaCS D45J 21x118mm)
Private house in
Photo by Marko Kajandu



Benchmark by Thermory thermo-ash decking (D4 sg2 26x130 mm. Installation: T-6 clip). NOA Restaurant in Estonia. Photo by Terje Ugandi.

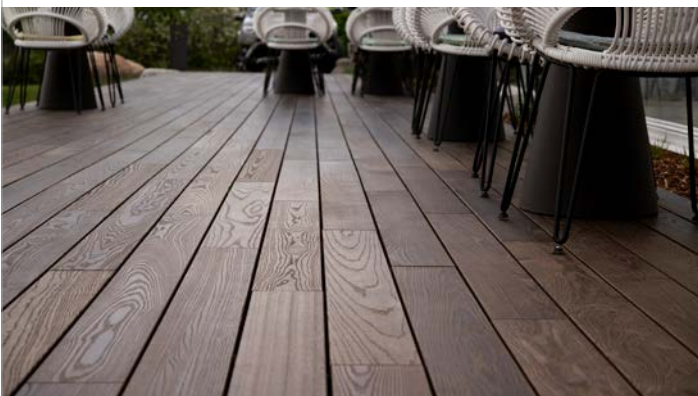

3.1.2 INSTALLATION: T-4, T-6 CLIP



HIDDEN FIXING
No visible screws



Thermory black-coated stainless steel clips “T-4” and “T-6” both create decking surface with no visible screws. Clip T-4 leaves a 4 mm gap between the boards and clip T-6 a 6 mm gap between the boards.



Benchmark by Thermory thermo-ash D4 sg2

For a consistent and clean look all Thermory ash decking boards can be ordered with Joint End Matching (JEM). It will also reduce waste to the minimum.

Standard selection available by pack. For the rest of products minimum order quantity applies.

Standard items

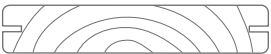
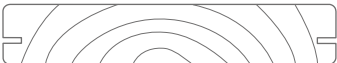
| PROFILE | WOOD | MODIFICATIONS | THICKNESS (MM) | WIDTH (MM) | PCS IN BUNDLE | INSTALLATION |
|--------------------------------------------------------------------------------------------|------------|----------------|----------------|------------|---------------|-------------------------|
| D4 sg2  | Thermo-ash | Intense thermo | 20 | 95 | 4 | T-4 clip: 2.7 pcs / 1 m |
| | | | 20 | 112 | 4 | |
| | | | 20 | 132 | 4 | T-6 clip: 2.7 pcs / 1 m |
| | | | 20 | 150 | 4 | |
| D4 sg2  | Thermo-ash | Intense thermo | 26 | 90 | 3 | T-4 clip: 2.7 pcs / 1 m |
| | | | 26 | 115 | 3 | |
| | | | 26 | 130 | 3 | T-6 clip: 2.7 pcs / 1 m |
| | | | 26 | 145 | 3 | |

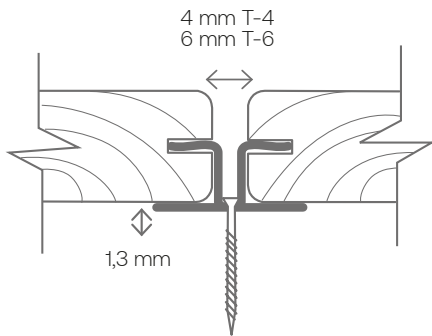

REQUIRED NUMBER OF T-4 OR T-6 CLIPS (WITH SCREWS):

2.7 clips per linear meter of decking board. Clips per wholesale packaging: 500 pcs, including screws + drill bit

For installation procedures and requirements please follow **Thermory Decking Installation Guide**. Watch the installation video on Thermory Youtube channel.

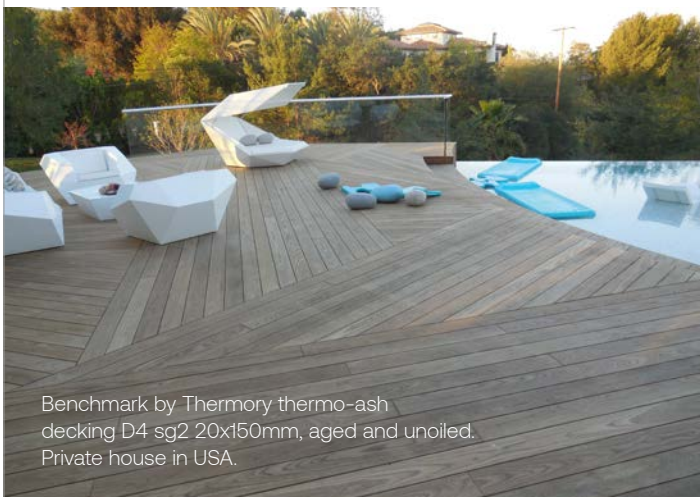

Benchmark by Thermory thermo-ash decking D4 sg2 20x150mm, aged and unoiled. Private house in USA.

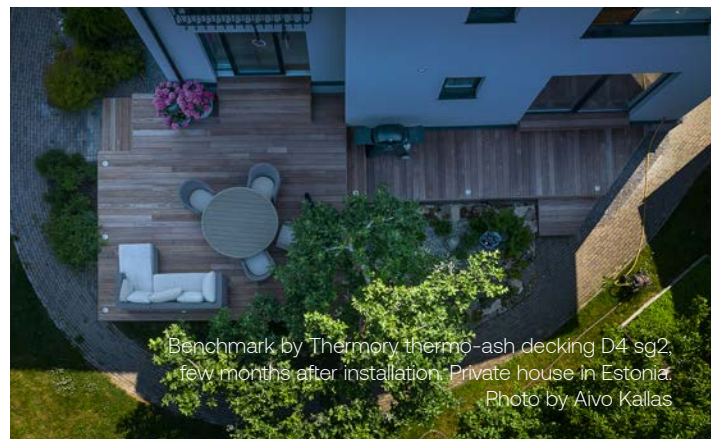

Benchmark by Thermory thermo-ash decking D4 sg2, few months after installation. Private house in Estonia. Photo by Aivo Kallas

All pictures are for illustrative purposes only. Actual products may differ in appearance as wood is a natural material - each piece is unique, just like us.



Benchmark by Thermory Thermo-ash decking (D4sg 20 x 112 mm)
Private house in Sweden

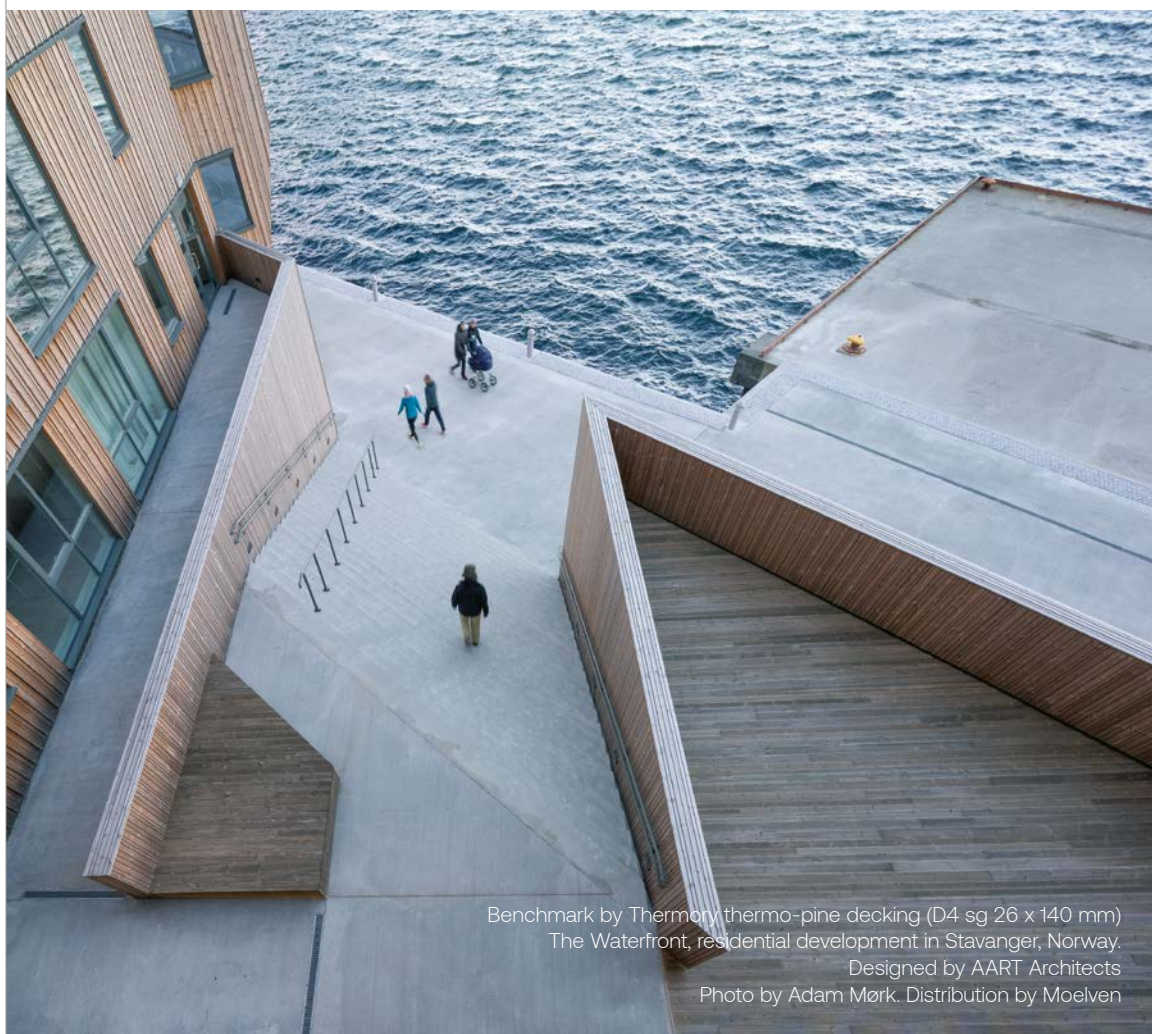

Benchmark by Thermory thermo-pine decking (D4 sg 26 x 140 mm)
The Waterfront, residential development in Stavanger, Norway.
Designed by AART Architects
Photo by Adam Mørk. Distribution by Moelven



3.1.3 INSTALLATION: PC CLIP



HIDDEN FIXING
No visible screws

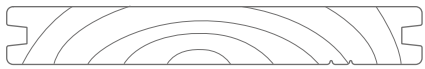

Standard items

| PROFILE | WOOD | MODIFICATIONS | THICKNESS (MM) | WIDTH (MM) | PCS IN BUNDLE | INSTALLATION |
|------------------------------------------------------------------------------------------|---------------|----------------------------------|----------------|------------|---------------|----------------------|
| D4 sg  | Thermo-pine | Intense thermo | 26 | 115 | 3 | PC clip: 3 pcs / 1 m |
| | | | 26 | 140 | 3 | |
| D4B sg  | Thermo-spruce | Intense thermo, rustic, brushing | 26 | 185 | 3 | |
| D30 sg  | Thermo-pine | Intense thermo | 26 | 115 | 3 | |
| | | | 26 | 140 | 3 | |



Thermory thermo-pine D4 sg



Thermory thermo-pine D30 sg

Thermory black coated PC clip leaves a distance of 6 mm between the boards.

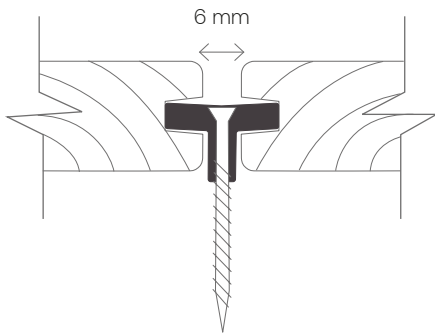

| REQUIRED NUMBER OF PC CLIPS (WITH SCREWS): |
|---------------------------------------------------------------------------------------------------------------------------------------------------------------------------------------------------|
| 3 clips per one linear meter of decking board. Clips per wholesale packaging: 500 pcs, including screws + drill bit. At end joint make sure to use one separate clip for both ends of the boards. |

For installation procedures and requirements please follow **Thermory Decking Installation Guide**. Watch installation videos on Thermory Youtube channel.

3.1.4 INSTALLATION: SUPRO H CLIP

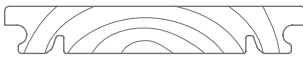

HIDDEN FIXING
No visible screws

| PROFILE | WOOD | MODIFICATIONS | THICKNESS (MM) | WIDTH (MM) | PCS IN BUNDLE | INSTALLATION |
|---------------------------------------------------------------------------------------------|-------------|----------------|----------------|------------|---------------|-----------------------------|
| D4-sg1f  | Thermo-ash | Intense thermo | 20 | 132 | 4 | SUPRO H clip: 2.7 pcs / 1 m |
| | Thermo-pine | Intense thermo | 26 | 140 | 3 | |

SUPRO H clip is available on special request.

3.1.5 INSTALLATION: TENI® CLIP



HIDDEN FIXING
No visible screws







TENI clips are made of a UV and water-resistant material (polyoxymethylene) that is optimized for outdoor conditions. The clips leave a 6-mm gap between the boards. The clip thickness provides an 8-mm distance between the board and the joist and prevents wood-to-wood contact to ensure the required ventilation.

For a consistent and clean look all Thermory ash decking boards can be ordered with Joint End Matching (JEM). It will also reduce waste to the minimum.

Standard selection available by pack. For the rest of products minimum order quantity applies.

Standard items

| PROFILE | WOOD | MODIFICATIONS | THICKNESS (MM) | WIDTH (MM) | PCS IN BUNDLE | INSTALLATION |
|-----------------------------------------------------------------------------------------|------------|----------------|----------------|------------|---------------|------------------------|
| D31  | Thermo-ash | Intense thermo | 20 | 95 | 4 | TENI® clip 3 pcs / 1 m |
| | | | 20 | 112 | 4 | |
| | | | 20 | 118 | 4 | |
| | | | 20 | 132 | 4 | |
| | | | 20 | 150 | 4 | |
| D32  | Thermo-ash | Intense thermo | 20 | 132 | 4 | |
| D34  | Thermo-ash | Intense thermo | 26 | 115 | 3 | |
| | | | 26 | 130 | 3 | |
| | | | 26 | 160 | 3 | |
| D38  | Thermo-ash | Intense thermo | 20 | 132 | 4 | |
| | | | 20 | 150 | 4 | |
| D41  | Thermo-ash | Intense thermo | 20 | 112 | 4 | |

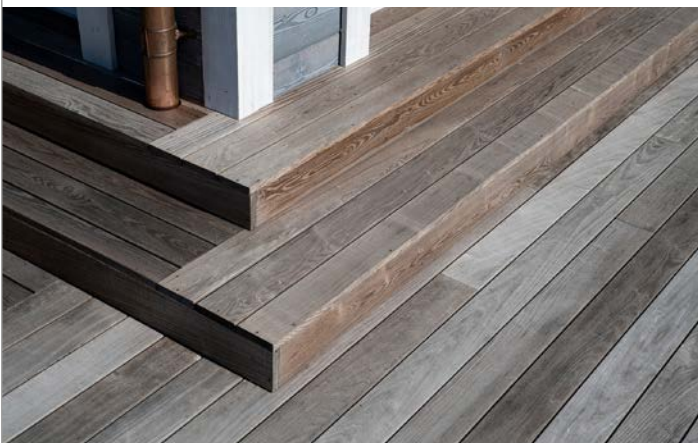
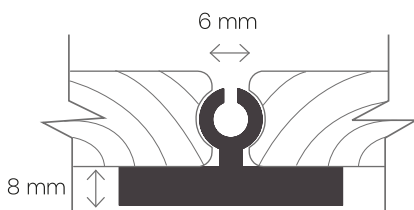

REQUIRED NUMBER OF TENI CLIPS:

3 clips per one linear meter of decking board. Clips per wholesale packaging: 100 pcs, including 4.2 x 45 mm screws (suited to timber and RELO T aluminum joists). With any other aluminum joists, it is necessary to either use special self-tapping screws or drill pilot holes).

For installation procedures and requirements please follow **Thermory Decking Installation Guide**. Watch installation videos on Thermory Youtube channel.

3.2. INSTALLATION WITH SCREWS









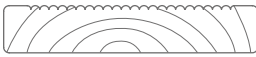

When installing Benchmark thermoash decking, pre-drilling is required in order to avoid cracking – countersinking the pre-drilled hole is a must.

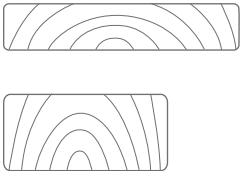

Always use stainless-steel screws for installing Thermory decking boards.

Standard items

| PROFILE | WOOD | MODIFICATIONS | THICKNESS (MM) | WIDTH (MM) | PCS IN BUNDLE | INSTALLATION |
|--------------------------------------------------------------------------------------------|------------------------|----------------|----------------|------------|---------------|----------------|
| D1  | Thermo-ash | Intense thermo | 26 | 130 | 3 | Visible screws |
| D3-A  | Thermo-pine | Intense thermo | 26 | 140 | 3 | Visible screws |
| D3-2  | Thermo-pine | Intense thermo | 26 | 115 | 3 | Visible screws |
| D4  | Thermo-ash | Intense thermo | 20 | 95 | 4 | Visible screws |
| | | | 20 | 112 | 4 | |
| | | | 20 | 132 | 4 | |
| | | | 20 | 150 | 4 | |
| | | | 20 | 190 | 4 | |
| | | | 26 | 90 | 3 | |
| | | | 26 | 115 | 3 | |
| | 26 | 130 | 3 | | | |
| | 26 | 145 | 3 | | | |
| | 26 | 160 | 3 | | | |
| | 42 | 42 | 4 | | | |
| | 42 | 90 | 2 | | | |
| | 42 | 135 | 2 | | | |
| | Thermo-pine | Intense thermo | 26 | 90 | 3 | |
| 26 | | | 115 | 4 | | |
| 26 | | | 140 | 3 | | |
| 42 | | | 42 | 4 | | |
| 42 | | | 90 | 2 | | |
| Thermo-spruce | Intense thermo, rustic | 26 | 185 | 3 | | |
| | | 42 | 68 | 2 | | |
| D15 R3  | Thermo-pine | Intense thermo | 26 | 140 | 3 | Visible screws |
| D11  | Thermo-ash | Intense thermo | 20 | 95 | 4 | Visible screws |
| D30  | Thermo-pine | Intense thermo | 26 | 115 | 3 | Visible screws |
| | | | 26 | 140 | 3 | |
| D48  | Thermo-pine | Intense thermo | 26 | 140 | 3 | Visible screws |
| D5  | Thermo-pine | Intense thermo | 26 | 117 | 3 | Visible screws |

All profiles are graded for top face as depicted here. For B side different grading rules apply.

For installation procedures and requirements please follow **Thermory Decking Installation Guide**.

All pictures are for illustrative purposes only. Actual products may differ in appearance as wood is a natural material – each piece is unique, just like us.



Benchmark by Thermory thermo-ash decking (D4. Installation: screws). Maidla Nature Villa in Estonia. Designed by Mari Hunt, b210 Architects. Photo by Elvo Jakobson



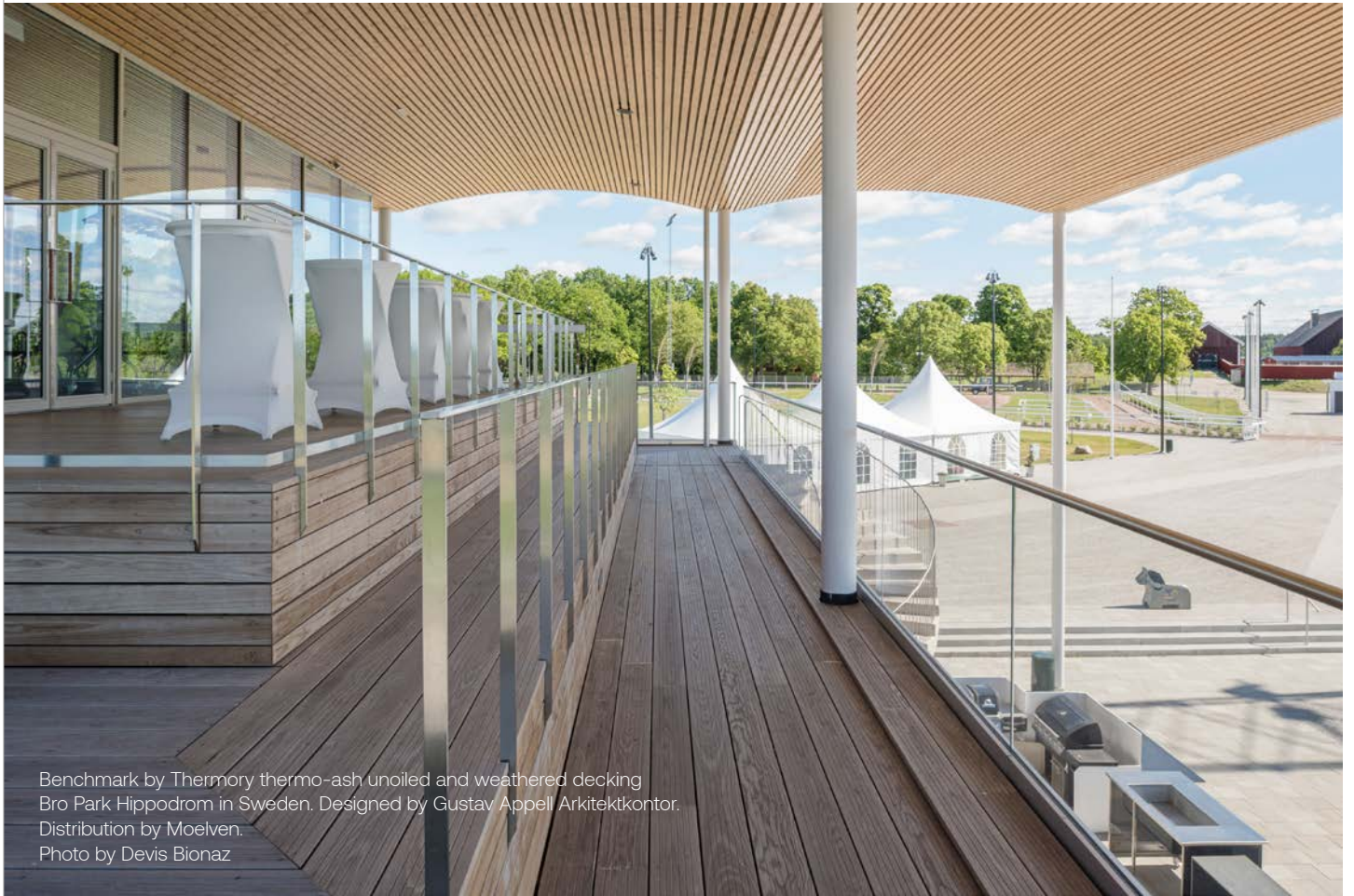

Benchmark by Thermory thermo-ash unoiled and weathered decking
Bro Park Hippodrom in Sweden. Designed by Gustav Appell Arkitektkontor.
Distribution by Moelven.
Photo by Devis Bionaz

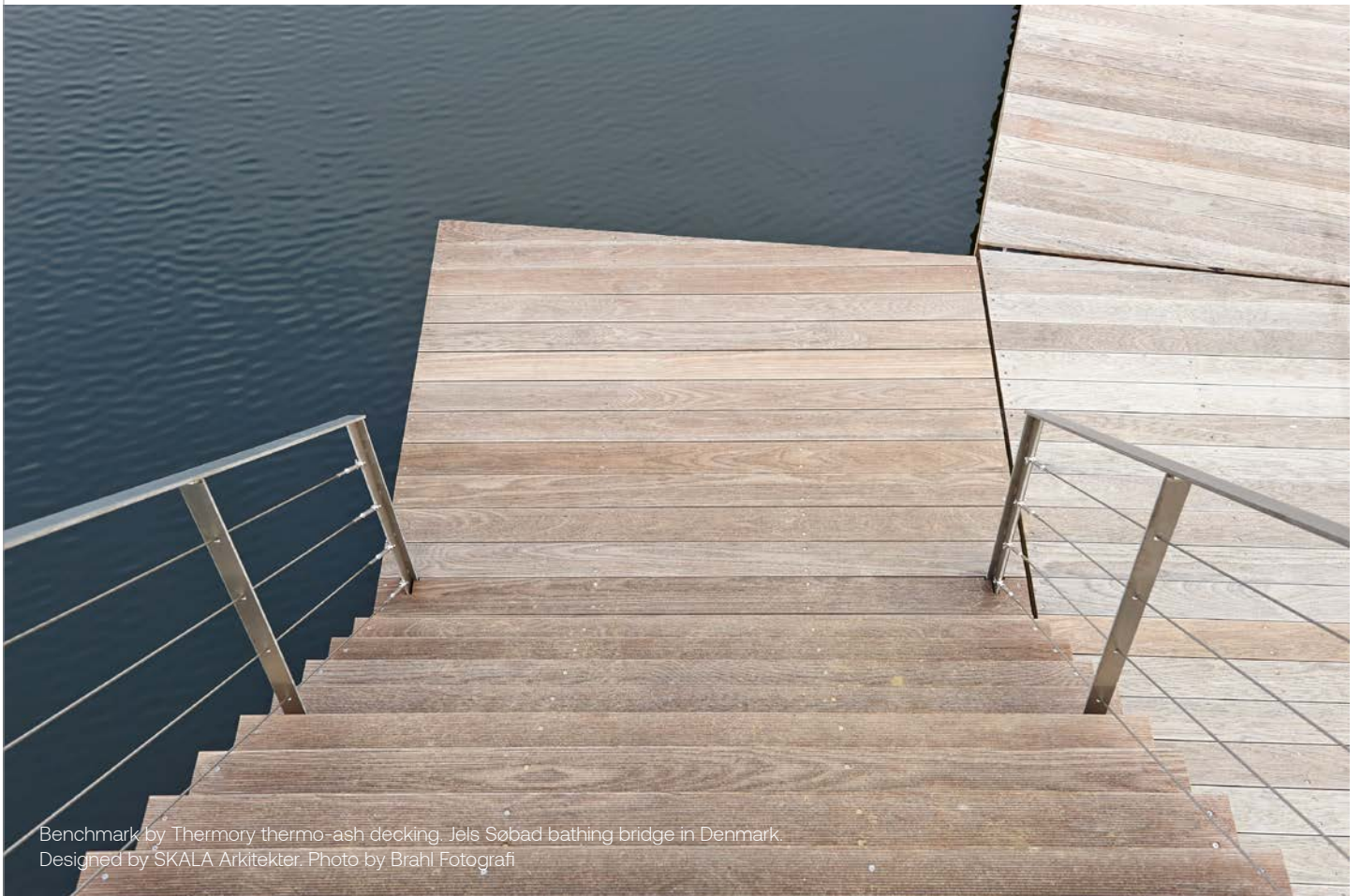

Benchmark by Thermory thermo-ash decking. Jels Søbad bathing bridge in Denmark.
Designed by SKALA Arkitekter. Photo by Brahl Fotografi



Benchmark by Thermory thermo-ash decking. Jels Søbad bathing bridge in Denmark. Designed by SKALA Arkitekter. Photo by Brahl Fotografi

Use spacers to elevate decking boards from joists to create an air gap of 4-8 mm between the decking and joists.

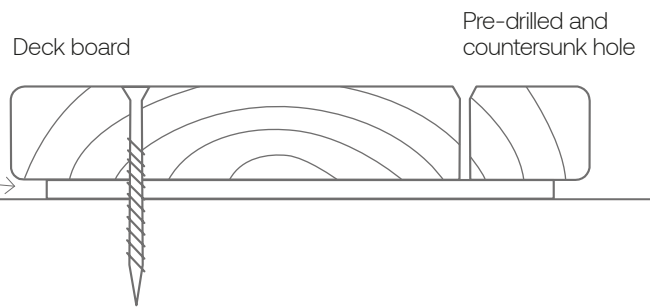

IMPORTANT!

The screw heads must not penetrate too deeply into the wood. They should fit snugly and be roughly level with the wood surface in order to reduce the risk of water absorption. In addition, driving the screw too deep into the wood can split the decking board and strip the fiber off the wooden joist, as well as cause the board to fracture around the screw head and squeak excessively.

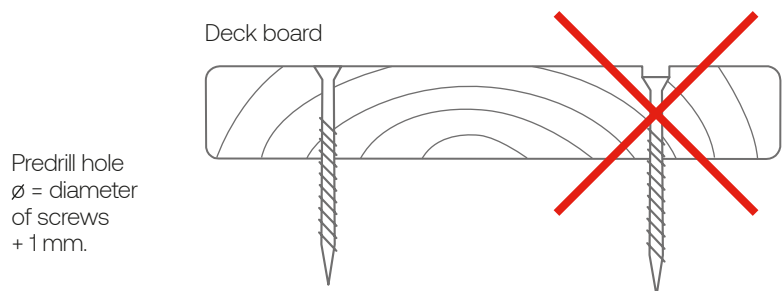

When screwing through the face of the boards, leave a distance of approximately 20 mm from the edges and at least 35 mm from the ends to avoid splitting.

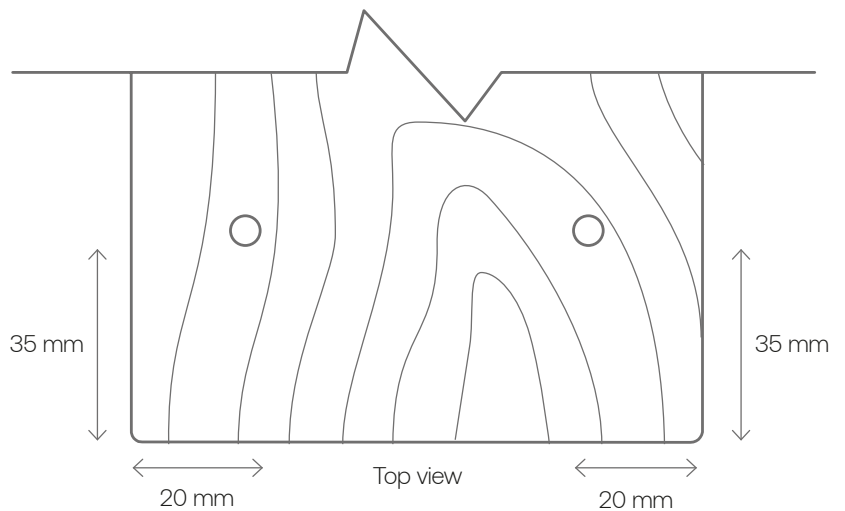

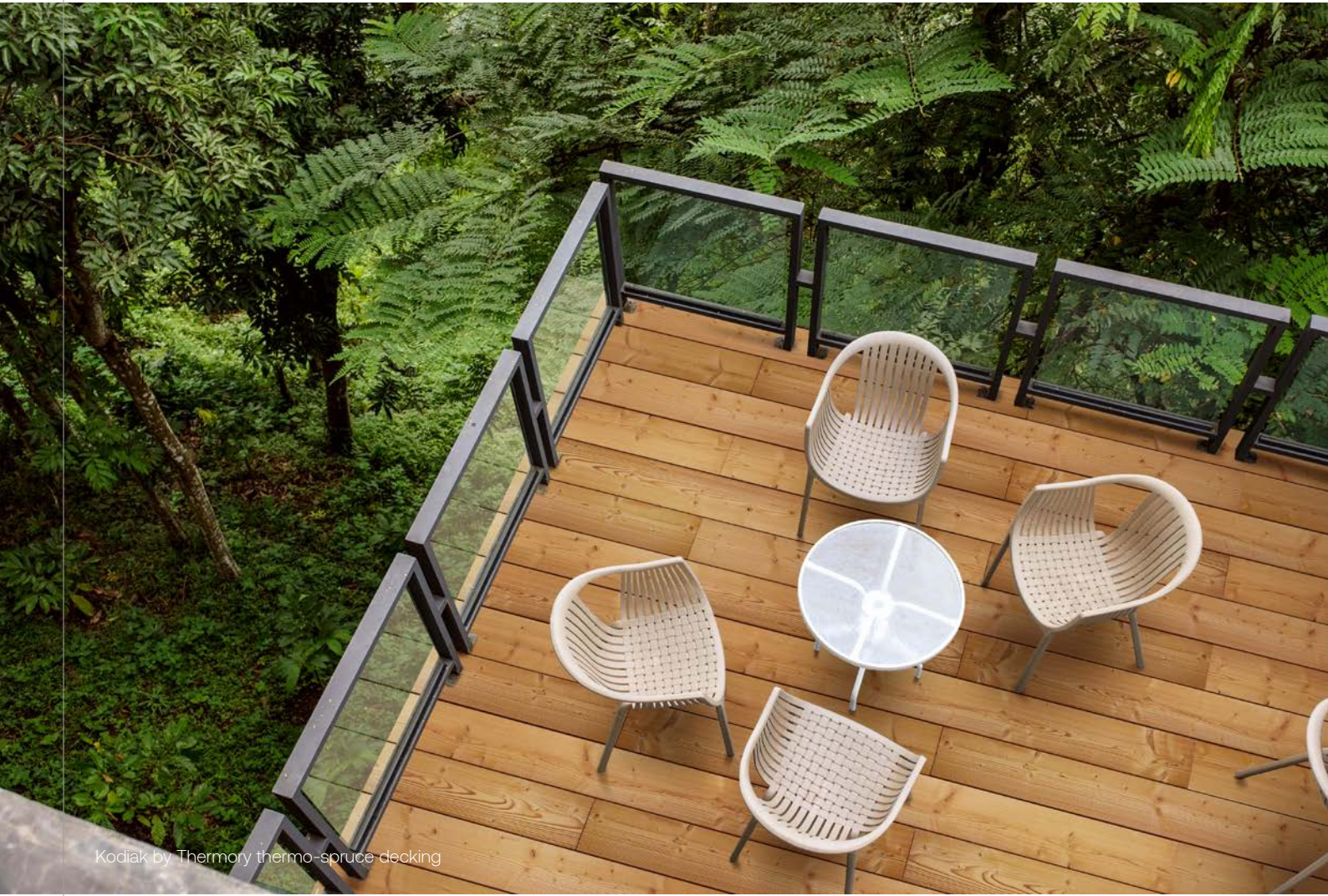

Kodiak by Thermory thermo-spruce decking



Kodiak by Thermory thermo-spruce decking

4. Thermory Rebel Series

Let your imagination loose and choose a solution from our Rebel Series that brings your unique character into your home or office.

4.1 KODIAK BY THERMORY



A little rugged. A little wild. A lot of board.

KODIAK by THERMORY gives your project the bold allure of the wilderness. Knotted spruce boards retain their natural appeal, while their extra-wide

size allows for faster installation. The brushed texture adds ruggedness without sacrificing the refined look you crave.

“Kodiak by Thermory” also available as cladding.



EXTRA WIDE BOARDS

Extra wide size for bold looks and faster installation



STABILITY

Dimensionally stable due to a significant reduction in equilibrium moisture content

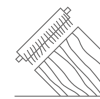

RUSTIC BRUSHED LOOKS

Brushing highlights the wood’s natural grain

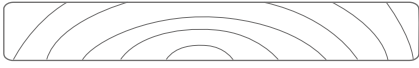
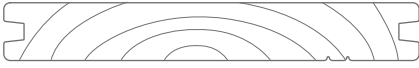
| PROFILE | WOOD | MODIFICATIONS | THICKNESS (MM) | WIDTH (MM) | PCS IN BUNDLE | INSTALLATION |
|----------------------------------------------------------------------------------------------|---------------|----------------------------------|----------------|------------|---------------|---------------------|
| D4  | Thermo-spruce | Intense thermo, rustic, brushing | 26 | 185 | 3 | Visible screws |
| D4B sg  | | | 26 | 185 | 3 | PC clip: 3 pcs/ 1 m |



For installation procedures and requirements please follow [Thermory Decking Installation Guide](#).

5. Thermory Modular Decking Systems

5.1 QUICK DECK BY THERMORY



Building a deck has never been easier

Thanks to QUICK DECK by Thermory modules, installing smart, attractive decking for your terrace has never been easier. With no substructure, tools or even screws required, these

decking modules can be quickly and easily connected with the help of weatherproof plastic supports. This beautiful screw-free decking is an ideal solution for roof decks and apartment

balconies. QuickDeck decking modules are made with thermally modified ash, which is extremely durable, dimensionally stable and knot free with a rich, deep tone.



HIGH DURABILITY

Thermo-ash for 25+ years of rot resistance



HIDDEN FIXING

No visible screws



EASY INSTALLATION

Easy to install and deinstall



SMOOTH FINISH

A splinter-free, comfortable deck



NO SUB-STRUCTURE

Can be installed on any even surface



Easy installation on solid ground – no tools, no screws needed

○ Standard items

| PROFILE | WOOD | MODIFICATIONS | THICKNESS (MM) | WIDTH (MM) | LENGTHS MM PER PACK | M ² IN BOX |
|-------------------|------------|------------------|----------------|------------|---------------------|-----------------------|
| QuickDeck® Maxi | Thermo-ash | Intense thermo ○ | 32 | 238 | 450/900/1350/1800 | 1.71 |
| QuickDeck® Mosaic | | ○ | 31 | 199 | 595/ 795 | 0.95 |



PACKAGING

SIX MODULES PER PACK:

1800 mm 2 pcs, 900 mm 2 pcs, 1350 mm 1 pc, 450 mm 1 pc. Covering an area of 1.71 m²

PACKAGING

SIX MODULES PER PACK:

795 mm 6 pcs, covering an area of 0.95 m²

Watch the installation video on Thermory Youtube channel.

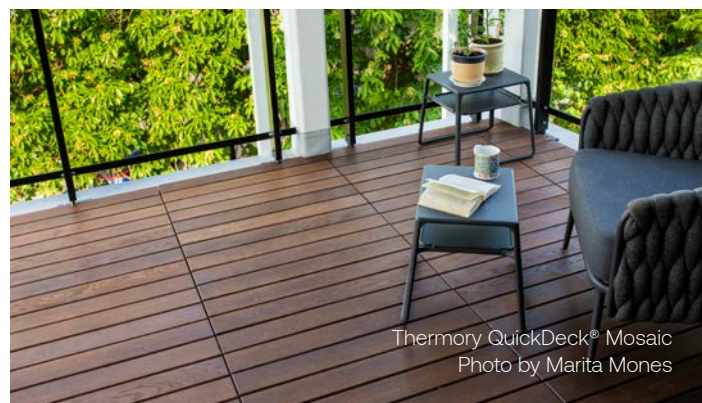

All pictures are for illustrative purposes only. Actual products may differ in appearance as wood is a natural material - each piece is unique, just like us.

5.2 FLOW BY THERMORY



Make waves on your deck.

FLOW by THERMORY decking combines the dimensional stability, durability, rich dark tone and gorgeous grain of thermo-ash with the stunning

innovative curved design from Flow. Six-piece decking modules match up perfectly with each other, creating an endlessly repeating pattern for a truly

unique deck. The installation is easy to do with Thermory TENI® clips which create a beautiful decking surface with no visible screws.



HIGH DURABILITY

Thermo-ash for 25+ years of rot resistance



HIDDEN FIXING

No visible screws

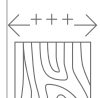

EXTRA WIDE BOARDS

Extra wide size for bold looks and faster installation



SMOOTH FINISH

A splinter-free, comfortable deck

| PROFILE | WOOD | MODIFICATIONS | THICKNESS (MM) | WIDTH (MM) | LENGTH (MM) | M ² IN BOX | INSTALLATION |
|------------------|------------|----------------|----------------|------------|-------------|-----------------------|-------------------------|
| Flow by Thermory | Thermo-ash | Intense thermo | 20 | 90-180 | 2400 | 1.83 | TENI® clip: 3 pcs / 1 m |



PACKAGING

Six boards per pack, covering an area of 1.83 m².

INSTALLATION

TENI® clip creates a beautiful decking surface with no visible screws and leaves a distance of 6 mm between the boards.



REQUIRED NUMBER OF TENI CLIPS:

3 clips per one linear meter of decking board. Clips per wholesale packaging: 100 pcs, including screws.

For installation procedures and requirements please follow [Thermory Decking Installation Guide](#). Watch the installation video on Thermory Youtube channel.

All pictures are for illustrative purposes only. Actual products may differ in appearance as wood is a natural material - each piece is unique, just like us.

5.3 HERRINGBONE BY THERMORY



Create a herringbone-patterned deck with exceptional ease.

HERRINGBONE by THERMORY makes it exceptionally easy to create a herringbone-patterned deck with no visible screws. It's quick too, requiring less than a third of the time that would normally be needed.

The Herringbone modular decking system range is made using ther-

mo-ash, which boasts the highest available durability class as well as being dimensionally stable and knot free with a rich, deep tone. The decking modules and starter and end cap modules are sold separately, allowing you to purchase just the parts you need for your deck size.



SMOOTH FINISH

A splinter-free, comfortable deck



HIGH DURABILITY

Thermo-ash for 25+ years of rot resistance



HIDDEN FIXING

No visible screws



EASY INSTALLATION

Easy to install and deinstall

| PROFILE | WOOD | MODIFICATIONS | MODULE THICKNESS (MM) | MODULE WIDTH (MM) | MODULE TOTAL LENGTH (MM) | M ² IN BOX | INSTALLATION |
|-----------------------------|------------|----------------|-----------------------|-------------------|--------------------------|-----------------------|--------------|
| Decking module | Thermo-ash | Intense thermo | 28 | 812 | 500 | 1.6 | screws |
| Starter and end cap modules | | Intense thermo | 28 | 812 | 394 | | screws |

How?



- Decking modules match up perfectly to create an effortless herringbone pattern.
- Starter and end cap modules allow a simple starting and ending of each pattern line.
- The under-mounting strips align the boards and make installation easy.

PACKAGING

MAIN DECKING MODULE BOX INCLUDES:

4 Herringbone decking modules (covering total 1.6m²) and screws. Extras included: 2 under-mounting strips for option edge mounting and 1 installation spacer every second box.

STARTER AND END CAP MODULE BOX INCLUDES:

2 starter modules and 2 end cap modules, plus screws.

For installation procedures and requirements please follow [Thermory Decking Installation Guide](#). Watch the installation video on Thermory Youtube channel.

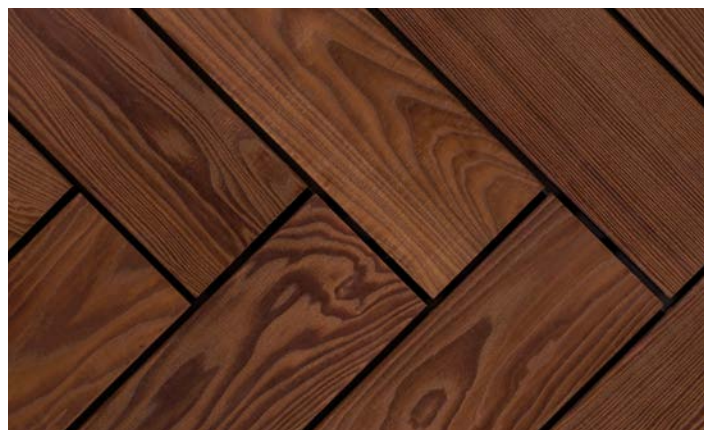

Herringbone and Benchmark products at Thermory Showroom in Estonia
Photo by Terje Ugandi

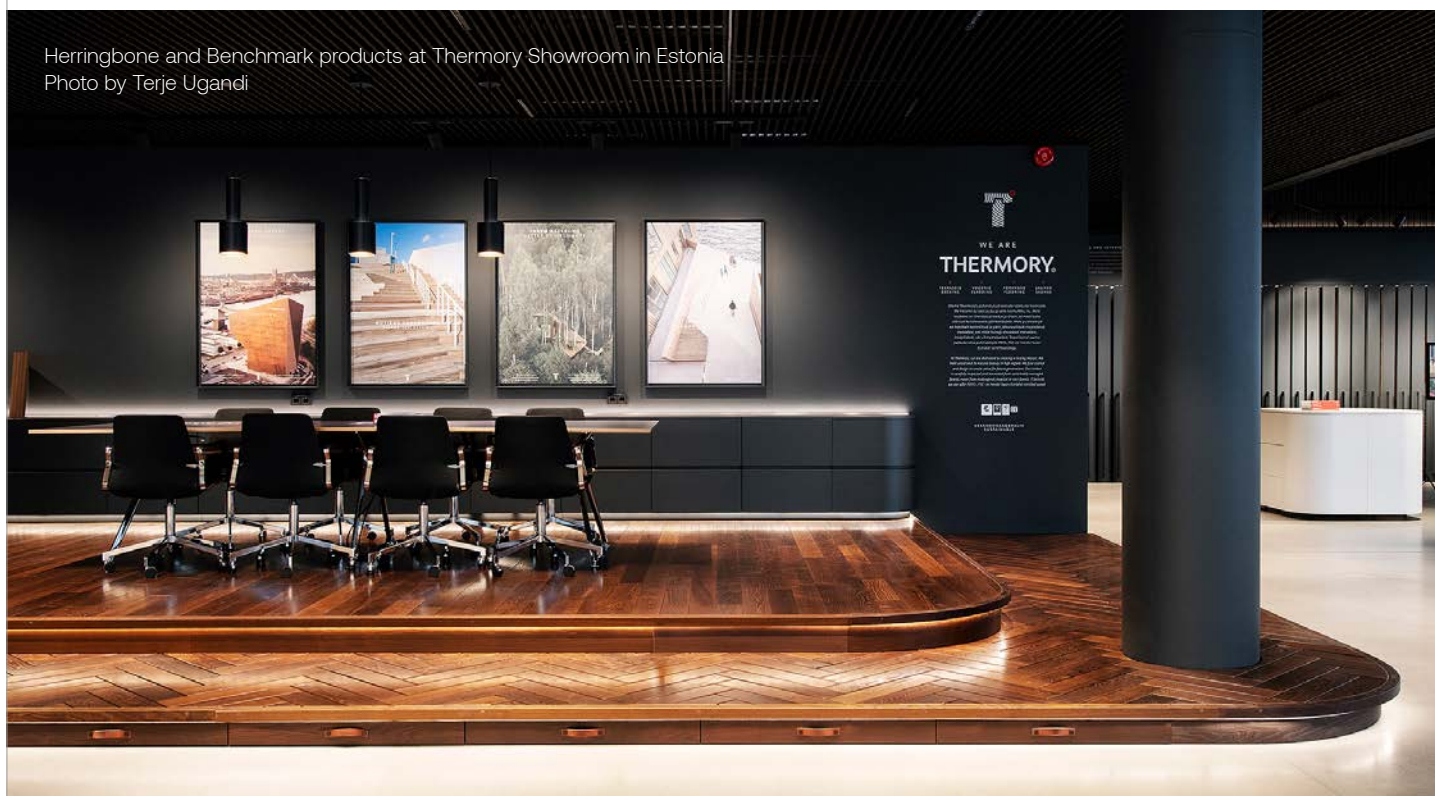

6. Additional information

6.1 BOARD LENGTHS

Boards are generally sold in random lengths, subject to stock availability.

- Thermory thermo-ash is generally produced in length range 1200-4800 mm.

- Thermory thermo-pine and thermo-spruce in length range 3000-6000 mm.

- PaCS decking boards such as D45J,

D4J and D30J are limited to maximum length 4800 mm.

Please check availability of specific lengths of interest from our sales team info@thermory.com.

6.2 SURFACE TEXTURES

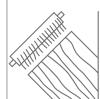

BRUSHING

Some of Thermory's finished cladding products **come with a brushed surface as standard**. Brushing beautifully highlights the wood's natural grain.



6.3 STORAGE

- Whenever possible, Thermory decking boards should be stored inside. The decking should be kept away from sunlight as UV rays will cause the color to fade. If kept outside, the boards should be elevated at least 150 mm from the ground, stacked evenly, and protected with a waterproof, light-impermeable cover. Leave the ends of the cover unfastened to provide ventilation while avoiding moisture damage.

- Thermory decking should never be left in the rain or exposed to excess moisture when in its original packaging, as it will not dry properly when tightly packaged. If possible, store the boards at the installation site for a few weeks prior to installation to allow them to acclimatize to the moisture conditions, using a protective cover to prevent moisture damage.

6.4 INSTALLATION

Using the correct installation and maintenance techniques will result in the most beautiful and long-lasting decking.

For installation procedures and requirements please follow Thermory Decking Installation Guide.

WATCH THE INSTALLATION VIDEOS ON THERMORY YOUTUBE CHANNEL



BUILDING A PROPER FOUNDATION

- Thermory decking must be laid on leveled joists.

- We recommend using Thermory Benchmark thermo-spruce, thermo-pine or metal joists – this will ensure that your joists last as long as your decking.

- Good drainage is essential in order to direct water away from the structure.

Make sure the ground beneath your decking is at a sufficient angle to avoid water pooling.

- Wood must not be in direct contact with wood. When installing decking boards with screws, use spacers or distance strips to leave approximately 4-8 mm between the boards and the joists. This will minimize trapped moisture and mold or fungi development.

- Decking boards should lay at least 100 mm above the ground. The best practice is to shim the joists to allow air circulation and drying.

- The maximum recommended space between joists is 400 mm.

SUBSTRUCTURE

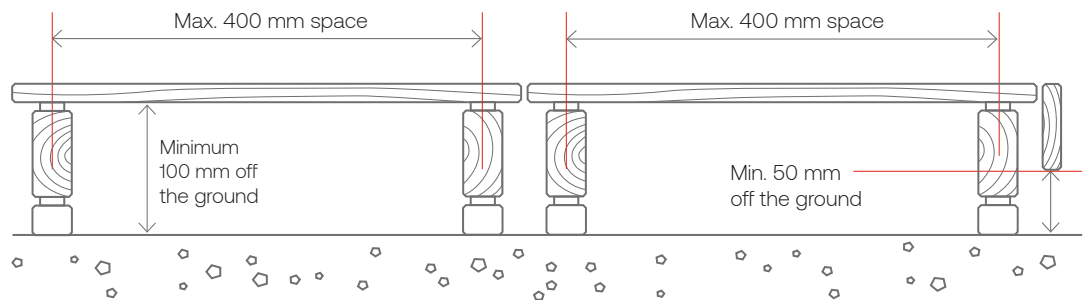

END-MATCHING JOINTS

With Thermory's exclusive JEM™ Joint, the ends of the boards do not need to rest on the support joists. This creates less waste, reducing labor costs and shortening the installation time. Each board must rest on and be fastened to a minimum of two joists.

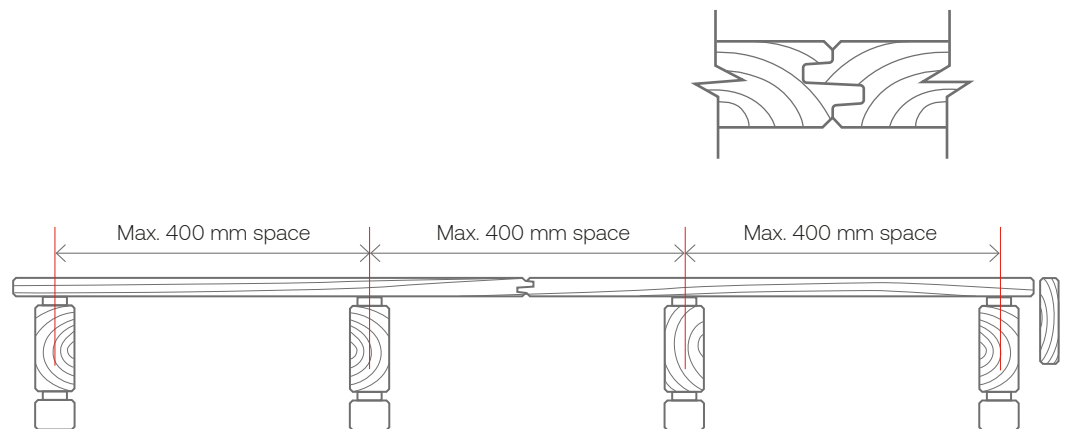



Unoiled Thermory Benchmark thermo-pine decking after 1 year
Photo and distribution: Moelven Norway

6.5 MAINTENANCE

For maintenance and care requirements please follow **Thermory Decking Maintenance Guide**.

- Thermally modified wood does not necessarily need surface treatment. Like any other wood, the surface of Thermory products naturally turns gray

over time. This process starts immediately after the products are installed and takes anything from a few months to a few years, depending on the intensity of UV radiation.

- In order to reduce the natural silvering process, Thermory boards can

be protected by coating them with a UV-resistant pigmented mineral oil. The use of organic oils is not recommended outdoors or in damp rooms, as they contain substances that provide a source of nutrition for biological organisms, such as bacteria, mold, etc.



Thermory Benchmark thermo-ash decking, aged and unoiled.



Thermory Benchmark thermo-pine decking, aged and unoiled.



Leave a lasting impact

THERMORY is a world leader in the thermal modification of wood. We offer high-quality, long-lasting solutions that benefit from environmentally friendly technology. We have spent the past two decades developing our expertise through close collaboration with architects, designers, builders and homeowners – constantly revising our product selection and refining our technology in the process.

THERMORY promotes a transparent and responsible corporate culture. We care about the environment and treat nature with deep respect. Our purchasing process is environmentally responsible, and we exercise high standards for quality and sustainability. Our timber is carefully inspected and harvested from sustainably managed forests.

- DECKING
- CLADDING
- INTERIOR
- SAUNA

If desired, we can offer PEFC, FSC or Nordic Swan Ecolabel-certified wood.



As a renewable resource that is both durable and an excellent insulator, wood is one of the most environmentally friendly choices for your construction projects. If you think it's important to protect our valuable resources long into the future, then we're on the same mission. We create lasting value, because we want to leave behind a more harmonious and sustainable world.

REAL WOOD PRODUCTS WITH BEAUTY AND STABILITY IN EVERY FIBER